

Lavatory Supply Tube

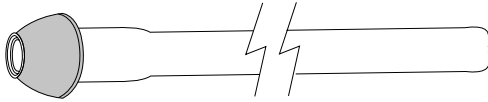

- Chrome plated

Item #	Description	Price		
		1-9	10-24	25+
87509	3/8" OD x 12"	1.42	1.33	1.25
87510	3/8" OD x 20"	2.00	1.96	1.90

Closet Flat Nose Supply Tube



- Chrome plated

Item #	Description	Price		
		1-9	10-24	25+
74588	3/8" OD x 12"	1.31	1.23	1.15
98567	3/8" OD x 20"	2.39	2.25	2.10

Closet Rubber Nose Supply Tube

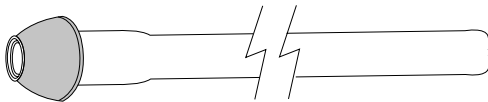

- Chrome plated

Item #	Description	Price		
		1-9	10-24	25+
87511	3/8" OD x 12"	1.88	1.77	1.65
87512	3/8" OD x 20"	2.39	2.25	2.10

Lavatory Supply Tube
Compression (Delta®) Supply Tube



- Chrome plated
- With compression fitting

Item #	Description	Price		
		1-9	10-24	25+
87513	3/8" OD x 12"	3.05	2.99	2.90
87514	3/8" OD x 20"	3.58	3.51	3.40



Polyethylene Supply Tubes

- Made of polyethylene PEX tubing
- With compression sleeves
- Flexible & durable

Lavatory		Price		
Item #	Description	1-9	10-24	25+
78-0132	3/8" OD x 12"	.68	.64	.60
78-0133	3/8" OD x 20"	.85	.80	.75

Closet		Price		
Item #	Description	1-9	10-24	25+
78-0134	3/8" OD x 12"	.68	.64	.60
78-0135	3/8" OD x 20"	.85	.80	.75



Flexible Sink Supply Lines
3/8" Compression x 1/2" IPS

			Price		
Item #	Description	Length	1-9	10-24	25+
58873	Nylon Braided	12"	1.95	1.91	1.85
78-0136	Nylon Braided	16"	2.16	2.12	2.05
58874	Nylon Braided	20"	2.05	2.01	1.95
96544	Stainless Braided	12"	2.32	2.27	2.20
78-0137	Stainless Braided	16"	2.95	2.78	2.60
96545	Stainless Braided	20"	3.30	3.10	2.90
96546	Stainless Braided	30"	4.55	4.28	4.00
96547	Stainless Braided	36"	5.15	4.84	4.53



No Burst® Faucet Connector
3/8" Compression x 1/2" IPS



			Price		
Item #	Description	Length	1-9	10-24	25+
87519	Stainless Braided	12"	3.35	3.15	2.95
87520	Stainless Braided	20"	4.43	4.16	3.90

Flexible Sink Supply Lines -----

PLUMBING

Flexible Sink Supply Lines
1/2" Compression x 1/2" IPS



Item #	Description	Length	Price		
			1-9	10-24	25+
87530	Nylon Braided	12"	2.25	2.12	1.98
78-0138	Nylon Braided	16"	2.32	2.27	2.20
87531	Nylon Braided	20"	2.37	2.32	2.25
87526	Stainless Braided	12"	2.89	2.83	2.75
78-0139	Stainless Braided	16"	3.21	3.15	3.05
87527	Stainless Braided	20"	3.79	3.71	3.60

Flexible Sink Supply Lines
1/2" IPS x 1/2" IPS



Item #	Description	Length	Price		
			1-9	10-24	25+
78-0140	Nylon Braided	12"	2.11	2.07	2.00
78-0141	Nylon Braided	16"	2.32	2.27	2.20
78-0142	Nylon Braided	20"	2.53	2.48	2.40
78-0143	Stainless Braided	12"	3.05	2.99	2.90
78-0144	Stainless Braided	16"	3.32	3.25	3.15
78-0145	Stainless Braided	20"	3.74	3.67	3.55

Flexible Sink Supply Lines
3/8" Compression x 3/8" Compression



Item #	Description	Length	Price		
			1-9	10-24	25+
78-0146	Nylon Braided	12"	2.79	2.73	2.65
78-0147	Stainless Braided	12"	2.95	2.89	2.80

Flexible Sink Supply Lines
Delta Style 3/8" Compression x 3/8" OD Copper Tube



Item #	Description	Length	Price		
			1-9	10-24	25+
87523	Stainless Braided	12"	4.64	4.36	4.08
87524	Stainless Braided	20"	5.34	5.02	4.70

Flexible Toilet Supply Lines

PLUMBING



Flexible Toilet Supply Lines
3/8" Compression x 7/8" Ballcock Nut

Item #	Description	Length	Price		
			1-9	10-24	25+
98441	Nylon Braided	12"	1.95	1.91	1.85
58875	Nylon Braided	20"	2.37	2.32	2.25
87525	Stainless Braided	9"	2.63	2.58	2.50
87521	Stainless Braided	12"	2.37	2.32	2.25
87522	Stainless Braided	20"	3.69	3.47	3.25



Flexible Toilet Supply Lines
1/2" Compression x 7/8" Ballcock Nut

Item #	Description	Length	Price		
			1-9	10-24	25+
87532	Nylon Braided	12"	2.37	2.32	2.25
87533	Nylon Braided	20"	2.68	2.63	2.55
87528	Stainless Braided	12"	3.84	3.76	3.65
87529	Stainless Braided	20"	4.49	4.22	3.95



Flexible Toilet Supply Lines
1/2" IPS x 7/8" Ballcock Nut

Item #	Description	Length	Price		
			1-9	10-24	25+
78-0148	Nylon Braided	12"	2.26	2.21	2.15
78-0149	Stainless Braided	12"	3.53	3.46	3.35

Dishwasher Supply Lines

PLUMBING



Dishwasher Supply Line with Elbow

- Stainless Steel Braided
- Includes 3/8" compression X 3/8" compression supply line and 3/8" compression X 3/8" MIP elbow

	Length	1-3	4-11	12+
12-60405.....	72"	8.68	8.51	8.25
12-60417.....	60"	6.79	6.65	6.45
Fluidmaster. 12-B6W48.....	48"	8.68	8.51	8.25



Dishwasher Supply Line

- Stainless Steel Braided
- 3/8" compression x 3/8" compression
- 48"

	Length	1-3	4-11	12+
12-48033.....	48"	6.05	5.93	5.75

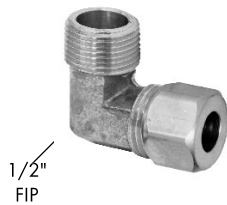

Dishwasher Elbow

- 3/8" compression X 3/8" MIP elbow

	1-3	4-11	12+
12-25300.....	1.16	1.14	1.10



SERVING THE INDUSTRY FOR 70 YEARS, WE ARE THE FIRST AND LAST PLACE TO SHOP FOR ALL YOUR PLUMBING NEEDS.

GAIN THE COMPETITIVE EDGE, GET THE INDUSTRIAL EDGE!

Call **1-800-441-9301** Fax **1-800-345-0209**
184

Chrome Plated Brass Angle Stops

PLUMBING



3/8" FIP x 3/8" OD Compression Angle Stop

	Inlet		Outlet	
	3/8" FIP	X	3/8" OD	
	1-9	10-24	25+	
87500	2.68	2.63	2.55	

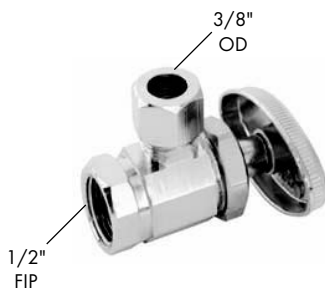

1/2" FIP x 3/8" OD Compression Angle Stop

	Inlet		Outlet	
	1/2" FIP	X	3/8" OD	
	1-9	10-24	25+	
87501	2.05	2.01	1.95	

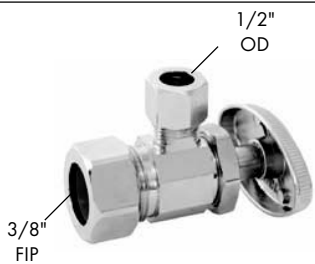

3/8" FIP x 1/2" OD Compression Angle Stop

	Inlet		Outlet	
	3/8" FIP	X	1/2" OD	
	1-9	10-24	25+	
73-0133	4.42	4.33	4.20	

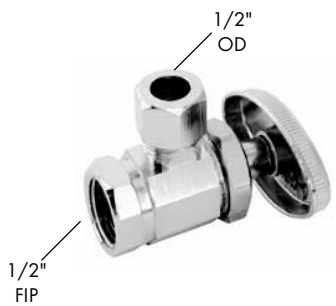

1/2" FIP x 1/2" OD Compression Angle Stop

	Inlet		Outlet	
	1/2" FIP	X	1/2" OD	
	1-9	10-24	25+	
87490	3.79	3.71	3.60	

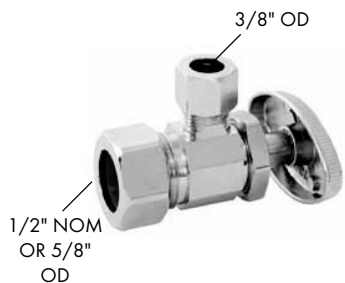

5/8" OD Compression x 3/8" OD Compression Angle Stop

	Inlet		Outlet	
	1/2" NOM or 5/8" OD	X	3/8" OD	
	1-9	10-24	25+	
87503	2.26	2.21	2.15	

Chrome Plated Brass Angle Stops

PLUMBING

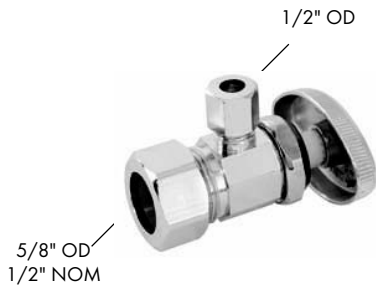

**5/8" OD Compression x 1/2" OD Compression
Angle Stop**

- Chrome plated

Inlet		Outlet
1/2" NOM or 5/8" OD Compression	X	1/2" OD Compression

	1-9	10-24	25+
78-0091	3.11	3.05	2.95

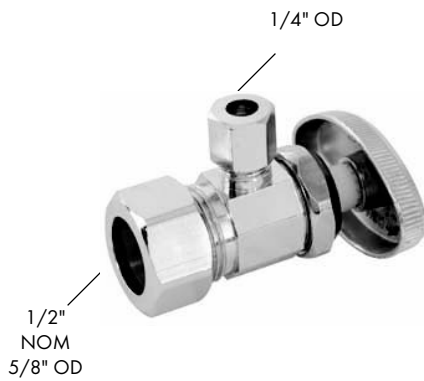

**5/8" OD Compression x 1/4" Compression
Angle Stop**

- Chrome plated

Inlet		Outlet
1/2" NOM or 5/8" OD Compression	X	1/4" OD Compression

	1-9	10-24	25+
78-0092	3.26	3.19	3.10

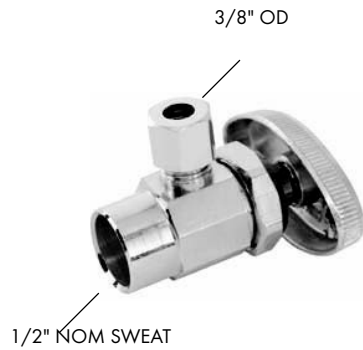

**1/2" Sweat x 3/8" OD Sweat
Angle Stop**

- Chrome plated

Inlet		Outlet
1/2" NOM SWEAT	X	3/8" OD Compression

	1-9	10-24	25+
87502	2.84	2.78	2.70



**1/2" FIP x 7/16" or 1/2" Slip Joint
Angle Stop**

- Chrome plated

Inlet		Outlet
1/2" FIP	X	7/16" or 1/2" Slip Joint

	1-9	10-24	25+
78-0090	3.05	2.99	2.90

Chrome Plated Brass Straight Stops

PLUMBING



1/2" Sweat x 3/8" OD Compression Chrome Plated Brass Straight Stop

• Chrome plated

Inlet		Outlet		
1/2" Sweat	X	3/8" OD Compression		
			1-9	10-24
87506			3.11	3.05
				25+
				2.95



1/2" FIP x 3/8" OD Compression Chrome Plated Brass Straight Stop

• Chrome plated

Inlet		Outlet		
1/2" FIP	X	3/8" OD		
			1-9	10-24
87505			2.84	2.78
				25+
				2.70



5/8" OD x 3/8" OD Compression Chrome Plated Brass Straight Stop

• Chrome plated

Inlet		Outlet		
1/2" NOM OR 5/8" OD	X	3/8" OD Compression		
			1-9	10-24
87507			3.11	3.05
				25+
				2.95



3/8" FIP x 3/8" OD Compression Chrome Plated Brass Straight Stop

• Chrome plated

Inlet		Outlet		
3/8" FIP	X	3/8" OD Compression		
			1-9	10-24
87504			3.05	2.99
				25+
				2.90

Chrome Plated Brass Dual Angle Stops -----

PLUMBING

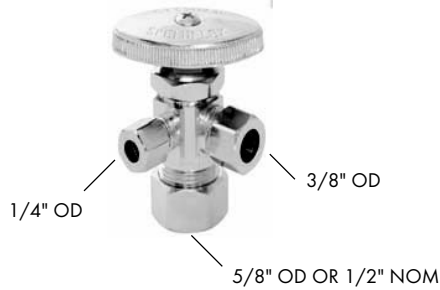

Dual Angle Stops

- 5/8" OD or 1/2" NOM x 3/8" OD x 1/4" OD
- Chrome plated

	1-9	10-24	25+
87495.....	5.21	5.11	4.95

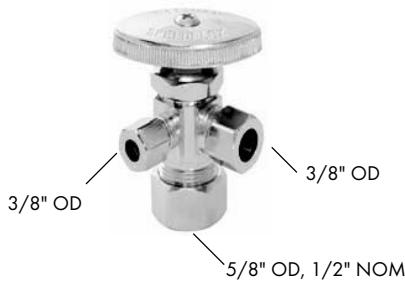

Dual Angle Stops

- 5/8" OD Compression or 1/2" NOM x 3/8" OD x 3/8" OD Compression
- Chrome plated

	1-9	10-24	25+
87508.....	4.66	4.38	4.10

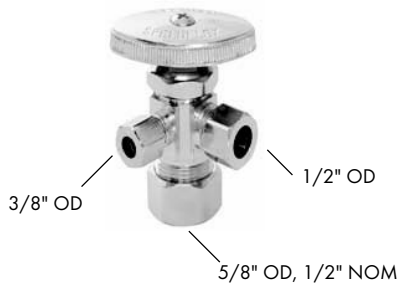

Dual Angle Stops

- 5/8" OD Compression or 1/2" NOM x 1/2" OD x 3/8" OD Compression
- Chrome plated

	1-9	10-24	25+
78-0093.....	5.11	5.01	4.85

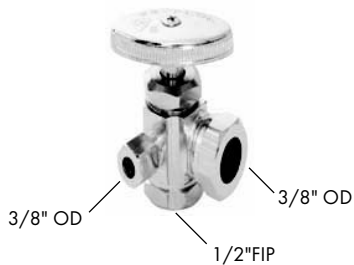

Dual Angle Stops

- 1/2" FIP x 3/8" OD Compression x 3/8" OD Compression
- Chrome plated

	1-9	10-24	25+
87493.....	4.66	4.38	4.10

Quarter Turn Chrome Plated Brass Angle Stops -----

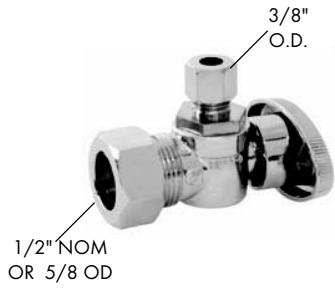

PLUMBING



Quarter Turn Chrome Plated Brass Angle Stops

- Quarter turn ball valves
- Chrome finish
- Hi temp Viton Seats

Inlet		Outlet	
1/2" NOM or 5/8" OD	X	3/8" OD	
	1-9	10-24	25+

 12-10738	2.89	3.05	2.75
 12-894003	3.15	3.09	2.99
 42-1000	6.20	6.08	5.89

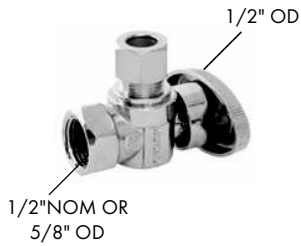

Quarter Turn Chrome Plated Brass Angle Stops

Inlet		Outlet	
1/2" NOM or 5/8" OD	X	1/2" OD	
	1-9	10-24	25+

 12-10739	3.25	3.19	3.09
--	------	------	------



Quarter Turn Chrome Plated Brass Angle Stops

Inlet		Outlet	
1/2" FIP	X	3/8" OD	
	1-9	10-24	25+

 12-10733	3.25	3.19	3.09
--	------	------	------



Quarter Turn Chrome Plated Brass Angle Stops

Inlet		Outlet	
1/2" FIP	X	1/2" OD	
	1-9	10-24	25+

 12-10734	3.25	3.19	3.09
--	------	------	------

Quarter Turn Chrome Plated Brass Angle Stops -----

PLUMBING



Quarter Turn Chrome Plated Brass Angle Stops

Inlet		Outlet	
1/2" NOM or 5/8" OD	X	7/16" or 1/2" Slip JT	
	1-9	10-24	25+
12-10740.....	3.55	3.48	3.37



Quarter Turn Chrome Plated Brass Angle Stops

Inlet		Outlet	
1/2" SWEAT	X	3/8" OD	
	1-9	10-24	25+
12-10757.....	3.55	3.48	3.37

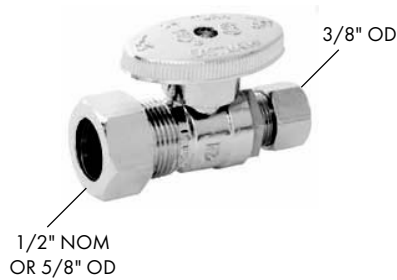

Quarter Turn Chrome Plated Brass Straight Top

Inlet		Outlet	
1/2" NOM or 5/8" OD	X	3/8" OD	
	1-9	10-24	25+
12-10756.....	3.25	3.19	3.09

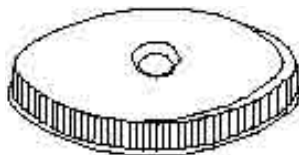

Chrome Angle Stop Handle

- 18 point broach pattern

	1-9	10-24	25+
87450.....	.51	.48	.45